

Steelie Panel Fence

PANEL FENCING

ST47

STEELINE GATE KIT – A STEP BY STEP GUIDE TO INSTALLATION

NOTE: Before assembling the gate, you must dig the holes for the posts. Allow the following dimensions for the distance between the post centres. **SINGLE GATES:** Total width of gate (edge to edge of gate posts) + 20mm. **DOUBLE GATES:** Total width of gate (edge to edge of outside gate posts) + 30mm. For clay or firm earth you should allow a 600mm deep hole, for sand or loose fill, allow a 900mm deep hole.

Step 1

Place the posts (stiles with spigots), rails, infill sheets and caps onto the ground, ensuring that they are protected underneath so that the COLORBOND® finish is not damaged. If you are installing a double gate kit, ensure that the infill sheets are overlapped on one rib only.

Step 2

Place the top rail (no drain holes) over the top of the infill sheet/s gently to avoid any scratching to the COLORBOND® finish. Now place the bottom rails (with drain holes) over the bottom of the infill sheet/s.

Step 3

Place the caps on the top of each of the posts (stiles with spigots). Now slide the spigots which are fixed to the posts (stiles), into the top and bottom rails.

Step 4

Ensure that the posts are held firmly into place and then fix the fasteners provided. A fastener must be placed through the top rail and spigot and into the first and second rib of the infill sheets from each end of the sheeting. This must be repeated on the bottom rails.

Step 5

Now you can fit the hinges, drop bolt and latch with striker. The latch and striker are to be fitted as per the instructions provided within packaging. NOTE: Remove all of the drill shavings (swarf) from the gate and rails, as it will cause the material to rust if it is not removed. To clean down the gate, use household washing detergent and a soft cloth.

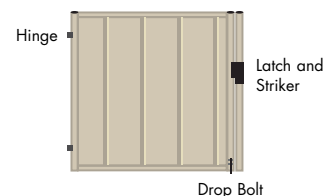
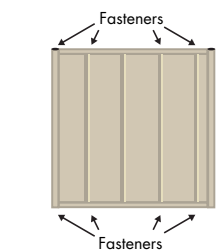
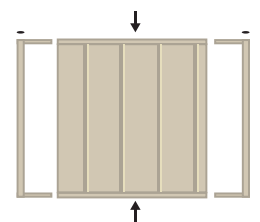
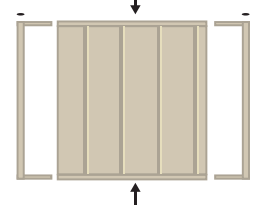
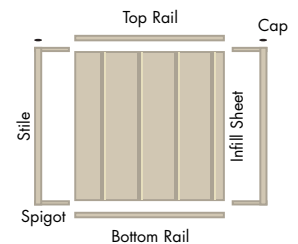

Steeline Panel Fence

PANEL FENCING

ST47



Colorbond® Zinalume®

Steeline Panel Fencing is the ideal boundary fence to compliment and secure your property. Our Panel fence comes in 2 different heights, 1.5 or 1.8 metres, and 3 different profiles. Both sides of the fence have full colour, posts, rails and sheets made from COLORBOND® Steel that is strong and will stand up to the harshest conditions. Note: Mini Corrugated only have colour on 1 side. Non standard heights are available.

Ph. 1300 STEELINE

steeline.com.au



Service over and above

Steeline Panel Fence

PANEL FENCING

ST47

STEP 1 – MARKING OUT YOUR POST HOLES

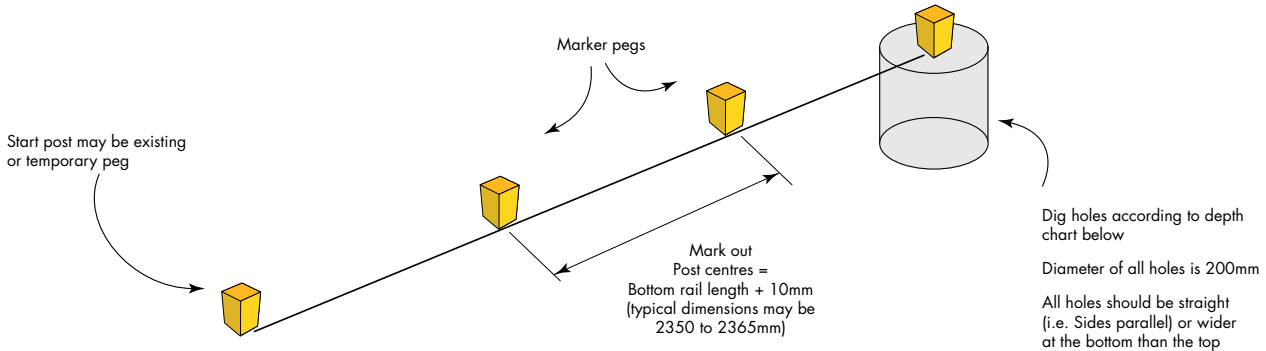

Important - Post lengths required will increase accordingly to cater for these ground conditions

Soil Type	Minimum Hole Depth	Approximate Concrete Required
Rock	300mm	1 Bag per hole (20kg bag)
Clay/Firm Earth	600mm	2 Bags per hole (20kg bags)
Sand/Loose Fill	900mm	3 Bags per hole (20kg bags)

Sloping or uneven sites

Additional Information

It's highly recommended that you invest a small amount of extra effort to rake your fence on sloping or uneven ground rather than stepping the panels. It achieves a better overall appearance as well as providing a stronger fence.

A. Marking Out Sloping Sites

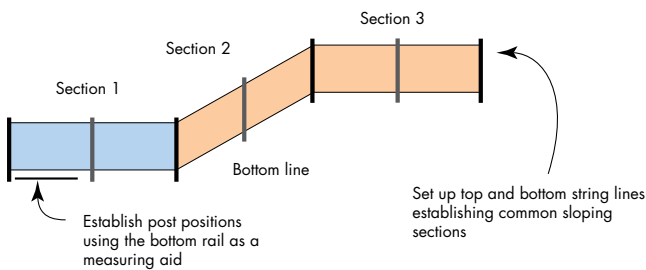

B. Cutting Of Sheets For A Raked Fence

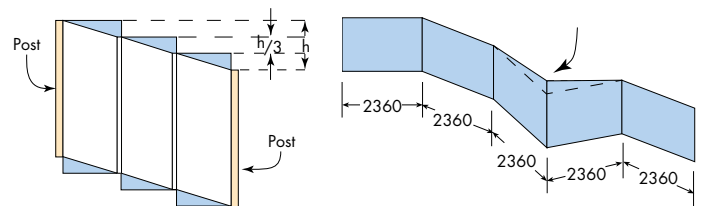

Uneven Sites

Vertical slitting of sheets may be required if slope is greater than 1 in 8. This may reduce the three sheet coverage to a point where one of the sheets may require vertical slitting. On COLORBOND® steel and ZINCALUME® steel this can be achieved using a straight edge and scoring with a tungsten tipped hand cutter available at most hardware stores, then bending and snapping the sheet. The top rail angles can be adjusted to create a smoother angle if desired. Note that the post height required will increase, so allow for this when fixing the posts in the ground.



The preferred method of cutting sheets is to use a nibble or tin snips

Steeline Panel Fence

PANEL FENCING

ST47

STEP 2 – SECURING POSTS

Place first post in hole. Adjust to correct height. Support post with temporary brace. Fill hole with fully mixed, wet concrete. Vibrate and compact the concrete to remove voids.

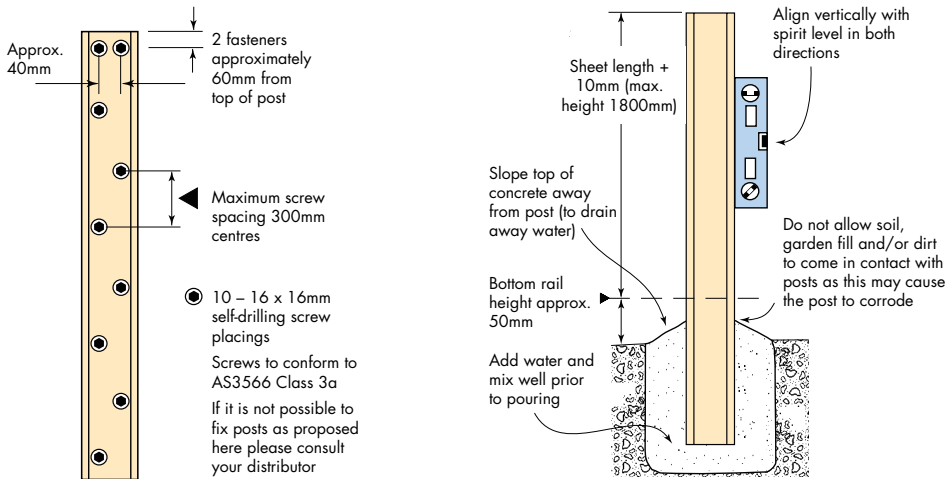

End Posts, Corner Posts and Junctions

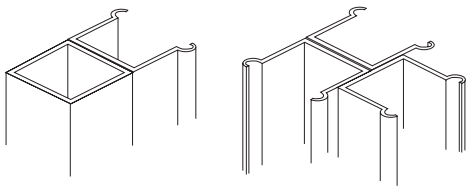

Dimensions of the SHS section and fence posts will vary according to the fence supplies. Contact your distributor for details.

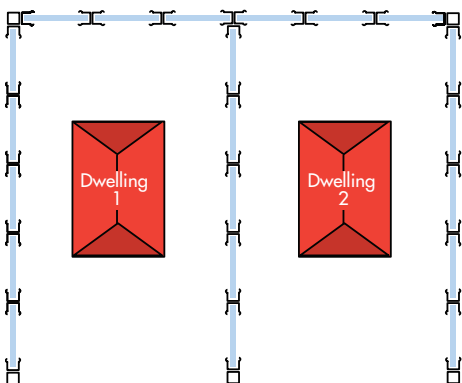

Tapering the Front of Your Fence

It is highly recommended that you taper the last two panels of your fence at an unsupported end, particularly where your fence extends beyond the front of your house. Cut sheets as per the instructions in the 'sloping or uneven sites' section. The minimal extra effort in tapering the unsupported end will provide a better looking fence than a stepped fence and is much stronger than leaving it at full height.

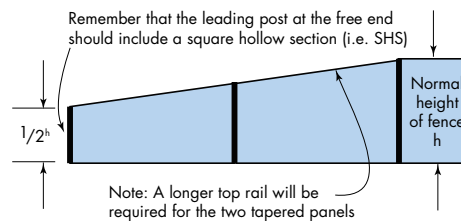

Example for 2365mm post centres		
Fence height	Tapered end height	Top rail length if tapered per two panels
1500mm	750mm	2385mm
1800mm	900mm	2400mm

Steeline Panel Fence

PANEL FENCING

ST47

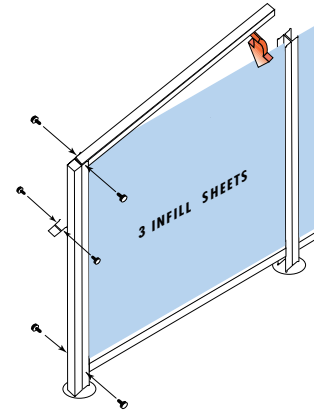
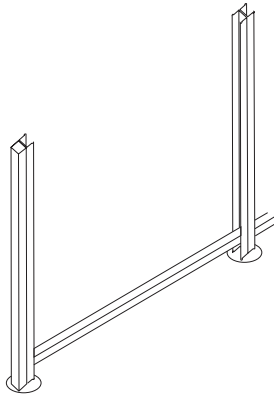

- Insert bottom rail between posts to determine exact locations of next post
- Adjust bottom rail to correct height – it is important to maintain a minimum gap of 50mm between bottom of rail and ground
- Screw fix the rails at this stage
- Place top rail into post and fix with self drilling screws on both sides of posts. Ensure that the self drilling screws are not fully tightened, as they need to be removed when inserting sheets. Ensure the position of the top rail is protruding 2mm above the top of the posts to reduce the risk of injury
- Continue this procedure until fence length is achieved

- Allow the concrete to cure overnight. Note: Longer curing period may be required in very cold and/or wet weather
- Unscrew top rail and remove
- Fit infill sheets into bottom rail ensuring correct lap as per diagrams below
- Place top rail on infill sheets working from one end to the other, locating the profile in the rail. A gentle tap with a rubber mallet may help
- Secure the top rail with self drilling screws on both sides
- Hose down with good water pressure when finished to remove any swarf such as drill filings or remnants from the nibbling process and
- Check installation

Maintenance and warranty of your fence

1. To keep your fence looking its best, simply hose your fence down periodically with water when washing the car or watering the garden. A soft broom should be sufficient to remove any cobwebs. Pay particular attention to the area under the top rail, which is sheltered from natural washing by rain.
2. Do not build up soil, garden fill and/or dirt against the bottom rails and posts of your fence as this will retain water and lead to corrosion. Do not use your fence as a retaining wall, as it is not designed for this purpose.
3. Avoid spraying the fence with garden sprays or fertilisers as these can damage the surface. If this occurs wash the fence down with water. Adequate drainage is needed to ensure that water does not pond in the

bottom rail and to assist in the removal of debris. This is often achieved by pre-punched holes in the bottom rail, or by designing the posts such that there is a clearance between the ends of the bottom rail and the posts.

4. Do not use touch up paint. Minor scratches should be left alone or the infill sheet replaced. Touch up paint will weather differently than COLORBOND® steel.
5. Fencing is backed by a 10 year warranty under the following conditions:
 - Installation > 1km from Marine or Industrial environment
 - Fence is installed to Manufacturer's guidelines
 - Fence is maintained regularly in accordance with Bluescope Steel guidelines.



Steeline Panel Fence

PANEL FENCING

ST47

Why choose Steeline fencing?

Steeline fencing is made from Australian COLORBOND® Steel which offers a large range of colours which is proven for its durability. This is backed by a Bluescope Steel 10 year warranty.

Steeline fencing systems do not rot, warp, are fire resistant and are not prone to termite attack. New solvents are available to remove graffiti, unlike timber. Steeline systems are user friendly and can be erected by the home handy man. (Please ask our friendly staff for a copy of the fitting instructions).

Security & Privacy

Given the amount of time families in Australia spend outside, security and privacy are of great concern. Steeline fencing systems assure peace of mind as your family is less susceptible to prying eyes and unwanted entry.

The Steeline fencing system is hard to climb as it has no foot holes for children to climb on, and panels cannot be loosened or removed.

Unlike timber fences, there is no risk younger families will fall victim to splinters or loose nails, nor be able to climb through any gaps in the fence.

This probably accounts as to why steel fences are the choice of Australian Kindergartens.

Colours & Profiles

A Steeline fence system is available in 3 profiles and has a wide range of 14 colours to select from, you can also incorporate a lattice screen if you to achieve a heritage look. It's easy to see why this versatile product has become so popular when you can alternate the colour of your panels and trim to suit the colours on your roofing and gutters. A Steeline fencing system can be adapted to whatever your needs. Note: All colours and profiles may not be available at some locations.

Double and single gate kits are available in both profiles, but are not available with lattice.

Whether it be a courtyard, pool fence, privacy fence or the whole backyard, the versatility of a Steeline fencing system allows you to design a safe and modern fence, while still giving an attractive appearance to our home.

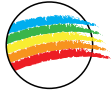

Colour Selection



Design Flexibility



Durability



Environmentally Friendly